

# Esercizio 1 CALCOLO delle AZIONI INTERNE

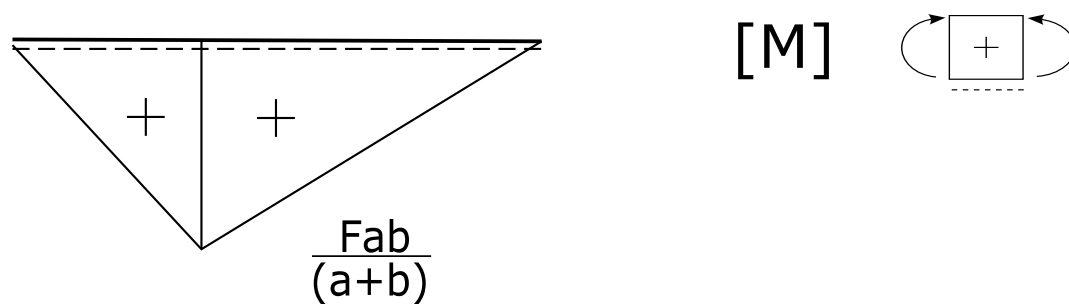

# Esercizio 2 CALCOLO delle AZIONI INTERNE

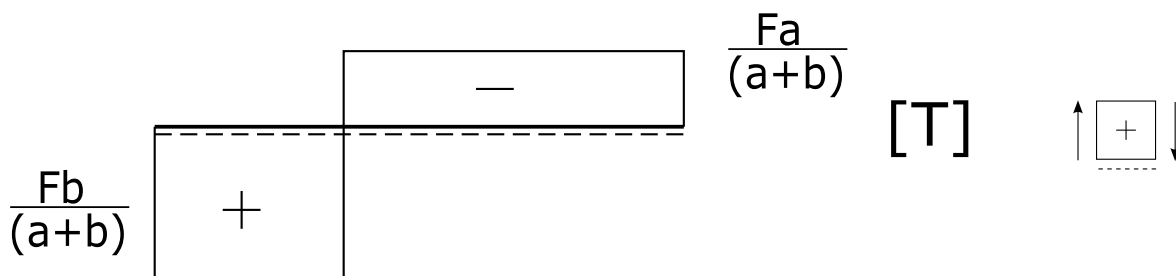
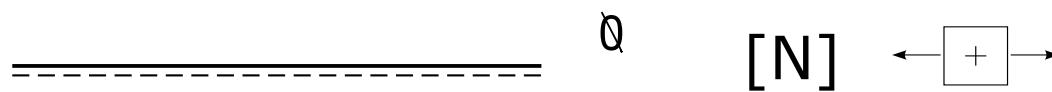
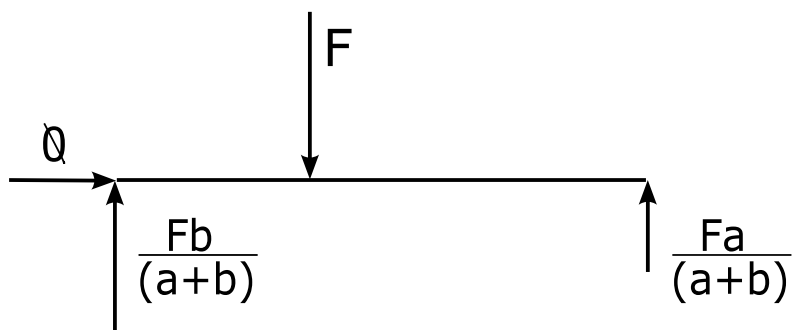
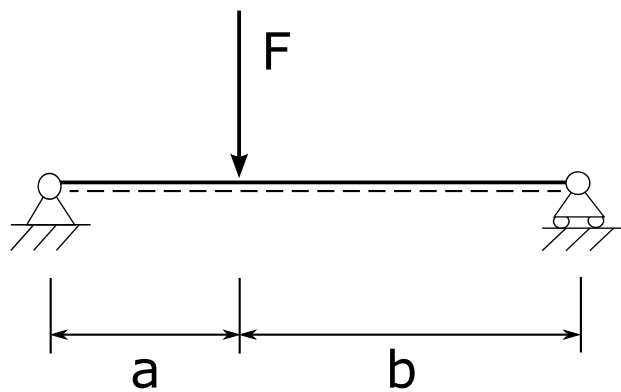
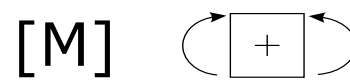
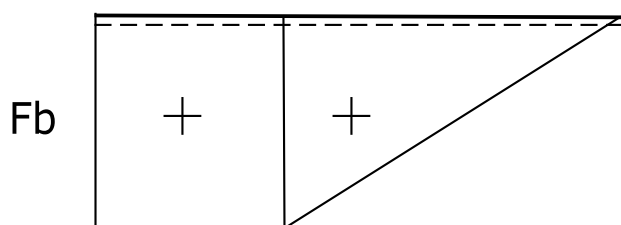
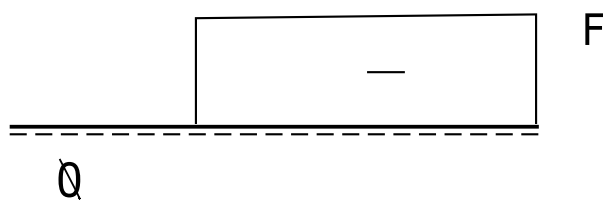
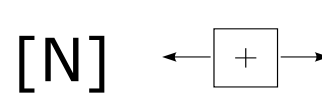
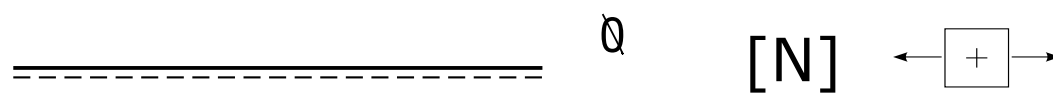
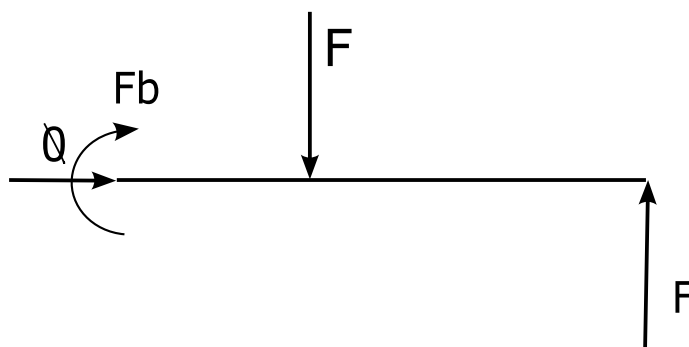
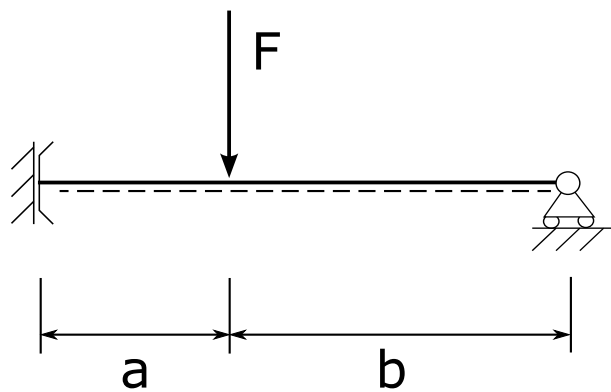

# Esercizio 3    CALCOLO delle AZIONI INTERNE

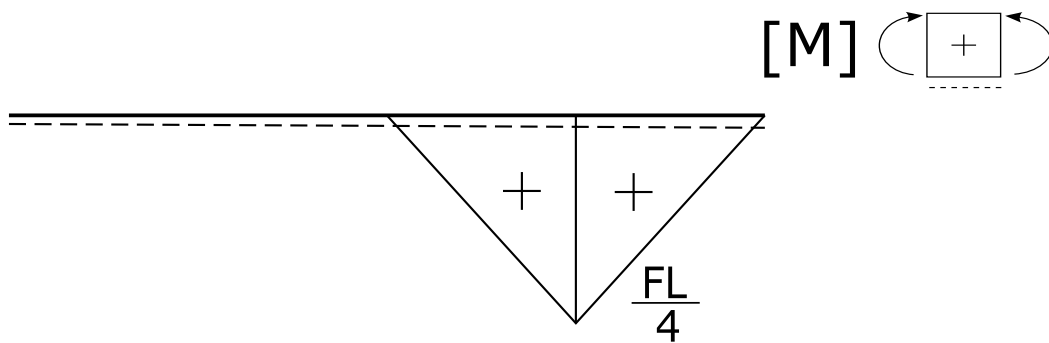
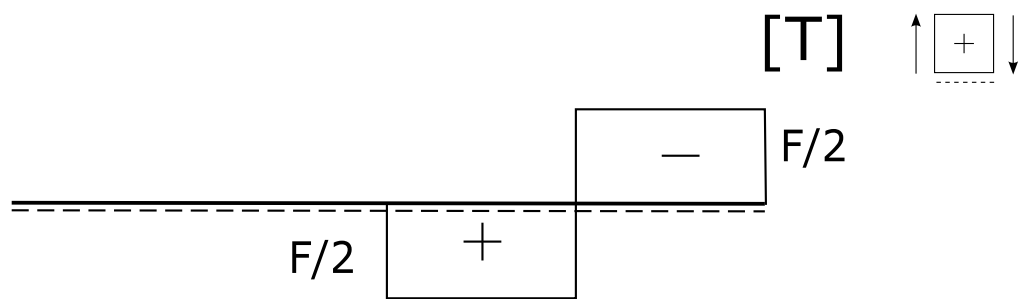
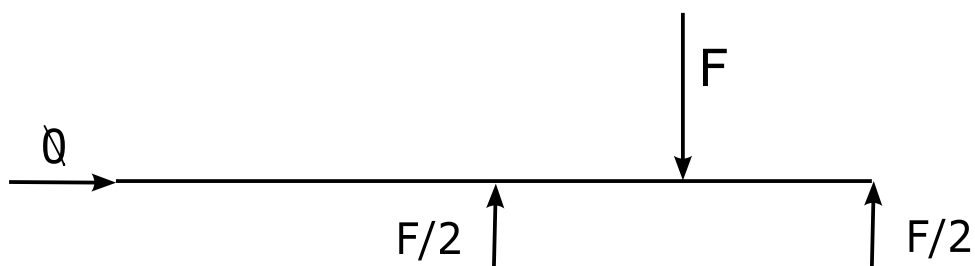
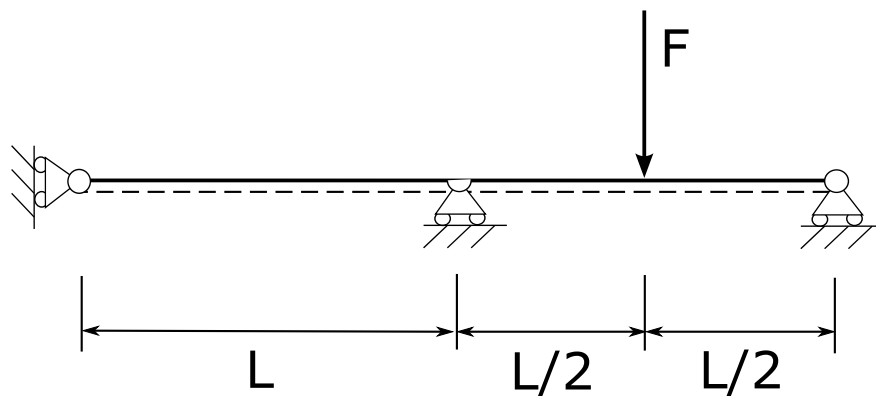

# Esercizio 4    CALCOLO delle AZIONI INTERNE

